



**SONOMA FORGE**  
**DESIGNER FAUCETS**

**2022**

**RETAIL PRICE LIST**  
**EFFECTIVE MAY, 1 2022**

(Subject to Change without Notice)

**[www.sonomaforge.com](http://www.sonomaforge.com)**  
**[info@sonomaforge.com](mailto:info@sonomaforge.com)**  
**800-330-5553**

# TABLE OF CONTENTS

		PAGE
<b>WATERBRIDGE</b>	LAVATORY & TUB FAUCETS	4-5
	TUB FAUCETS WITH HANDSHOWERS	6
	ACCESSORIES	7
	EXPOSED SHOWERS	8-11
	EXPOSED SHOWER PARTS	12-13
	ACCESSORIES	14-15
<b>WHEREVER</b>	LAVATORY & TUB FAUCETS	16-17
	ACCESSORIES	18
	CONCEALED SHOWER CONTROLS	19
	CONCEALED SHOWER PARTS	20-21
<b>HANDSHOWERS</b>	HANDSHOWER KITS	22-23
<b>CIXX</b>	FAUCETS & ACCESSORIES (While supplies last)	24
	CONCEALED SHOWERS & ACCESSORIES (While supplies last)	25
<b>STRAP</b>	FAUCETS & ACCESSORIES	26
	CONCEALED SHOWER CONTROLS	27
	CONCEALED SHOWER PARTS	28-29
<b>SANS HANDS</b>	SENSOR FAUCETS	30-31
<b>KITCHEN, BAR, &amp; PREP FAUCETS</b>	BRUT	32-33
	WATERBRIDGE	34
	CUVEE & WINGNUT	35
	BROWNSTONE (For a limited time)	36
	POINT OF USE FAUCETS	37
<b>DRAINS</b>	KITCHEN DRAINS & ACCESSORIES	38
	LAVATORY DRAINS & ACCESSORIES	39
	FLOOR / SHOWER DRAINS	40
<b>MISC. PARTS</b>	MISCELLANEOUS & REPLACEMENT PARTS	41
<b>INDEX</b>	PRODUCT INDEX BY MODEL NUMBER	42
<b>TERMS &amp; CONDITIONS</b>	TERMS & CONDITIONS	43

**PLEASE VISIT OUR WEBSITE FOR COMPLETE TERMS AND CONDITIONS**

# ORDERING SONOMA FORGE PRODUCTS

## INTRODUCTION TO SONOMA FORGE PRODUCT CODES

Sonoma Forge is sold exclusively through a network of authorized showrooms, which can be found on our website. Orders use the following codes, mostly abbreviating the following information: Collection, Application, Spout Style, Size, and Finish.

### COLLECTION

BRUT = Brut  
BS = Brownstone  
CV = Cuvee  
CX = Cixx  
SANS = Sans Hands (sensor faucets)  
ST = Strap  
WB = Waterbridge  
WE = Wherever  
WN = Wingnut

### TYPE

ACC = Accessory  
LAV = Lavatory Faucet  
RTF = Tub Faucet  
SHW = Shower / Shower Accessory

### APPLICATION

DM = Deck Mounted  
FM = Floor Mounted  
WM = Wall Mounted

### SPOUT STYLE

GN = Gooseneck  
CAP = Cap  
FX = Fixed  
LBO = Elbow  
LG = Large Gooseneck  
SQ = Square  
SW = Swiveling  
WF = Waterfall

### SIZE (if applicable)

S = Short  
T = Tall  
L = Long  
LG = Large

### STANDARD FINISH CODES (Only for)

AB = Antique Bronze (Brownstone Collection)  
B = Brass (CiXX Collection)  
ORB = Oil Rubbed Bronze  
MB = Matte Black  
RC = Rustic Copper  
RN = Rustic Nickel  
S = Stainless Steel (CiXX Collection)  
SN = Satin Nickel

## HANDLE & DRAIN OPTIONS

"Tee" handles are standard for the Waterbridge and Wherever Collections.

Cross handles are available at no additional cost when ordered with the fixture.

Handle prices listed herein are for single replacement handles only.

This also applies to alternate lavatory drains. Most lav faucets include a drain. If a specific drain is preferred, simply note on your original order. Prices listed are for standalone or replacement drains.

Kitchen and sensor faucets do not include drains.

## AVAILABILITY





To service your customers better, we attempt to maintain inventory of our most popular product/finish combinations. For current availability, it is most efficient to email Sonoma Forge at: [info@sonomaforge.com](mailto:info@sonomaforge.com)

## SPECIAL ORDER FINISHES & CUSTOM PRODUCTS

Please contact us regarding custom products and non-standard finishes.

Special order and custom products are not returnable.

# WATERBRIDGE COLLECTION

PHOTO	DESCRIPTION	PART NUMBER	LIST PRICE
	<p><b>SHORT DECK MOUNT LAV FAUCET WITH WATERFALL SPOUT</b></p> <p>8" SPREAD, CENTER TO CENTER 2-1/4" SPOUT HEIGHT 7-3/4" CENTER TO TIP</p>	WB-LAV-DM-WF-S	\$1790
	<p><b>TALL DECK MOUNT LAV FAUCET WITH WATERFALL SPOUT</b></p> <p>8" SPREAD, CENTER TO CENTER 6-1/2" SPOUT HEIGHT 7-3/4" CENTER TO TIP</p>	WB-LAV-DM-WF-T	\$1790
	<p><b>WALL MOUNT LAV FAUCET WITH WATERFALL SPOUT</b></p> <p>8" SPREAD, CENTER TO CENTER 10" REACH, WALL TO TIP 4" DROP, CENTER TO TIP</p>	WB-LAV-WM-WF	\$1990
	<p><b>FLOOR MOUNT TUB FILLER WITH WATERFALL SPOUT</b></p> <p>8" SPREAD, CENTER TO CENTER 7-3/4" CENTER TO TIP 29-1/2" SPOUT HEIGHT</p>	WB-RTF-FM-WF	\$2290
	<p><b>REMOTE TUB DRAIN &amp; OVERFLOW</b></p> <p>ADJUSTABLE OVERFLOW HEIGHT FROM 19" TO 25-1/2"</p> <p>TUB GRID DRAIN INCLUDED</p>	WB-RTDO	\$2990
	<p><b>TUB FILLER</b></p>	WB-RTF-DM-WF	\$2090
	<p><b>TUB FILLER</b></p>	WB-RTF-WM-WF	\$2090
	<p><b>TUB FILLER w/ SPOUT HEIGHT UP TO 41"</b></p>	WB-RTF-FM-WF-CSTM	\$3290

# WATERBRIDGE COLLECTION

PHOTO	DESCRIPTION	PART NUMBER	LIST PRICE
	<p>SHORT DECK MOUNT LAV FAUCET WITH ELBOW SPOUT</p> <p>8" SPREAD, CENTER TO CENTER 3-3/4" SPOUT HEIGHT 6-1/2" CENTER TO AERATOR</p>	WB-LAV-DM-LBO-S	\$1790
	<p>TALL DECK MOUNT LAV FAUCET WITH ELBOW SPOUT</p> <p>8" SPREAD, CENTER TO CENTER 6-1/4" SPOUT HEIGHT 6-1/2" CENTER TO AERATOR</p>	WB-LAV-DM-LBO-T	\$1790
	TUB FILLER	WB-RTF-DM-LBO	\$2090
	<p>WALL MOUNT LAV FAUCET WITH ELBOW SPOUT</p> <p>8" SPREAD, CENTER TO CENTER 10" REACH, WALL TO TIP 2" DROP, CENTER TO TIP</p>	WB-LAV-WM-LBO	\$1890
	TUB FILLER	WB-RTF-WM-LBO	\$1990
	<p>FLOOR MOUNT TUB FILLER WITH ELBOW SPOUT</p> <p>8" SPREAD, CENTER TO CENTER 6-1/2" CENTER TO AERATOR 29-1/2" SPOUT HEIGHT</p>	WB-RTF-FM-LBO	\$2290
	TUB FILLER w/ SPOUT HEIGHT UP TO 41"	WB-RTF-FM-LBO-CSTM	\$3290

# WATERBRIDGE COLLECTION

PHOTO	DESCRIPTION	PART NUMBER	LIST PRICE
-------	-------------	-------------	------------

**THESE SYSTEMS ARE MADE TO ORDER, AND MULTIPLE VERSIONS ARE AVAILABLE.  
PLEASE CONTACT SONOMA FORGE FOR MORE INFORMATION.**



**FLOOR MOUNT TUB FILLER  
WITH WATERFALL SPOUT**

**INCLUDES HOSE AND HANDSHOWER**

**8" SPREAD**

**WB-RTF-FM-WF-HS**

**\$5550**



**WALL MOUNT TUB FILLER  
WITH WATERFALL SPOUT  
AND HANDSHOWER**

**8" SPREAD**

**WB-RTF-WM-WF-HS**

**\$5050**



**FLOOR MOUNT TUB FILLER  
WITH ELBOW SPOUT**

**INCLUDES HOSE AND HANDSHOWER**

**8" SPREAD**

**WB-RTF-FM-LBO-HS**

**\$5550**









**WALL MOUNT TUB FILLER  
WITH ELBOW SPOUT  
AND HANDSHOWER**

**8" SPREAD**

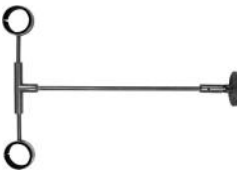



**WB-RTF-WM-LBO-HS**

**\$5050**

# WATERBRIDGE COLLECTION





PHOTO	DESCRIPTION	PART NUMBER	LIST PRICE
	<p><b>RISER EXTENSION KIT FOR WATERBRIDGE DECK MOUNTED FAUCETS</b></p> <p>ADJUSTABLE FROM 1/2" TO 2-1/2" SOLD AS PAIR</p>	WB-ACC-LEG EXT	\$240
	<p><b>OPTIONAL STABILIZER TEE FOR FLOOR-MOUNTED FAUCETS</b></p> <p>ATTACHES TO WALL, TUB, OR FLOOR 16" CENTER TO END CAN BE CUT TO LENGTH</p>	WB-ACC-TEE	\$575
	<p><b>CLAMP WITH HAND WAND HOOK</b></p> <p>ATTACHES TO WATERBRIDGE FIXTURES</p>	WB-ACC-CLAMP-HS	\$250
	<p><b>CLAMP WITH SOAP BASKET</b></p> <p>ATTACHES TO WATERBRIDGE FIXTURES</p>	WB-ACC-CLAMP-SD	\$525
	<p><b>2-HOLE DECK PLATE WITH 8" SPREAD 11" X 3" OVERALL</b></p>	WB-ACC-DM-PLT	\$380
	<p><b>2-HOLE WALL PLATE WITH 8" SPREAD 11" X 3" OVERALL</b></p>	WB-ACC-WM-PLT	\$380
	<p><b>4" REPLACEMENT HANDLE</b></p>	WB-HNDL-T	\$85
	<p><b>3-1/2" REPLACEMENT CROSS HANDLE</b></p>	WE-HNDL-C	\$85

# WATERBRIDGE EXPOSED SHOWERS





PHOTO	DESCRIPTION	PART NUMBER	LIST PRICE
	<p>MODEL 840 WITH 8" RAINHEAD</p> <p>8" SPREAD, CENTER-TO-CENTER</p> <p>INCLUDES REMOTE ANTI-SCALD MIXING VALVE</p> <p>SEE PAGES 12-13 FOR MORE OPTIONS</p>	WB-SHW-840	\$4500
	<p>MODEL 850 WITH 8" RAINHEAD AND HANDSHOWER</p> <p>8" SPREAD, CENTER-TO-CENTER</p> <p>INCLUDES REMOTE ANTI-SCALD MIXING VALVE</p> <p>SEE PAGES 12-13 FOR MORE OPTIONS</p>	WB-SHW-850	\$5700
	<p>MODEL 870 WITH 8" RAINHEAD AND TUB FILLER</p> <p>8" SPREAD, CENTER-TO-CENTER</p> <p>INCLUDES REMOTE ANTI-SCALD MIXING VALVE</p> <p>SEE PAGES 12-13 FOR MORE OPTIONS</p>	WB-SHW-870	\$5900
	<p>MODEL 880 WITH 8" RAINHEAD, HANDSHOWER, AND TUB FILLER</p> <p>8" SPREAD, CENTER-TO-CENTER</p> <p>INCLUDES REMOTE ANTI-SCALD MIXING VALVE</p> <p>SEE PAGES 12-13 FOR MORE OPTIONS</p>	WB-SHW-880	\$6800







# WATERBRIDGE EXPOSED SHOWERS

PHOTO	DESCRIPTION	PART NUMBER	LIST PRICE
	<p>MODEL 1040 WITH 8" RAINHEAD</p> <p>10" SPREAD, CENTER-TO-CENTER</p> <p>INCLUDES REMOTE ANTI-SCALD MIXING VALVE</p> <p>SEE PAGES 12-13 FOR MORE OPTIONS</p>	WB-SHW-1040	\$6100
	<p>MODEL 1050 WITH 8" RAINHEAD AND HANDSHOWER</p> <p>10" SPREAD, CENTER-TO-CENTER</p> <p>INCLUDES REMOTE ANTI-SCALD MIXING VALVE</p> <p>SEE PAGES 12-13 FOR MORE OPTIONS</p>	WB-SHW-1050	\$7300
	<p>MODEL 1070 8" RAINHEAD &amp; FOOTWASH</p> <p>10" SPREAD, CENTER-TO-CENTER</p> <p>INCLUDES REMOTE ANTI-SCALD MIXING VALVE</p> <p>SEE PAGES 12-13 FOR MORE OPTIONS</p>	WB-SHW-1070	\$7500
	<p>MODEL 1080 8" RAINHEAD, HANDSHOWER, AND FOOTWASH</p> <p>10" SPREAD, CENTER-TO-CENTER</p> <p>INCLUDES REMOTE ANTI-SCALD MIXING VALVE</p> <p>SEE PAGES 12-13 FOR MORE OPTIONS</p>	WB-SHW-1080	\$8400







# WATERBRIDGE EXPOSED SHOWERS

PHOTO	DESCRIPTION	PART NUMBER	LIST PRICE
	<p>MODEL 940 THERMOSTATIC SYSTEM WITH 8" RAINHEAD</p> <p>10-3/4" SPREAD, CENTER-TO-CENTER</p> <p>SEE PAGES 12-13 FOR MORE OPTIONS</p>	WB-SHW-940	\$6500
	<p>MODEL 950 THERMOSTATIC SYSTEM WITH 8" RAINHEAD AND HANDSHOWER</p> <p>10-3/4" SPREAD, CENTER-TO-CENTER</p> <p>SEE PAGES 12-13 FOR MORE OPTIONS</p>	WB-SHW-950	\$7700
	<p>MODEL 970 THERMOSTATIC SYSTEM WITH 8" RAINHEAD AND TUB FILLER</p> <p>10-3/4" SPREAD, CENTER-TO-CENTER</p> <p>SEE PAGES 12-13 FOR MORE OPTIONS</p>	WB-SHW-970	\$7900
	<p>MODEL 980 THERMOSTATIC SYSTEM WITH 8" RAINHEAD, HANDSHOWER, AND TUB FILLER</p> <p>10-3/4" SPREAD, CENTER-TO-CENTER</p> <p>SEE PAGES 12-13 FOR MORE OPTIONS</p>	WB-SHW-980	\$8800

# WATERBRIDGE EXPOSED SHOWERS

PHOTO	DESCRIPTION	PART NUMBER	LIST PRICE
	<p>MODEL 1140 THERMOSTATIC SYSTEM WITH 8" RAINHEAD</p> <p>10-3/4" SPREAD, CENTER-TO-CENTER</p> <p>SEE PAGES 12-13 FOR MORE OPTIONS</p>	<p>WB-SHW-1140</p>	<p>\$8500</p>
	<p>MODEL 1150 THERMOSTATIC SYSTEM WITH 8" RAINHEAD AND HANDSHOWER</p> <p>10-3/4" SPREAD, CENTER-TO-CENTER</p> <p>SEE PAGES 12-13 FOR MORE OPTIONS</p>	<p>WB-SHW-1150</p>	<p>\$9700</p>
	<p>MODEL 1170 THERMOSTATIC SYSTEM 8" RAINHEAD &amp; FOOTWASH</p> <p>10-3/4" SPREAD, CENTER-TO-CENTER</p> <p>SEE PAGES 12-13 FOR MORE OPTIONS</p>	<p>WB-SHW-1170</p>	<p>\$9900</p>
	<p>MODEL 1180 THERMOSTATIC SYSTEM 8" RAINHEAD, HANDSHOWER, AND FOOTWASH</p> <p>10-3/4" SPREAD, CENTER-TO-CENTER</p> <p>SEE PAGES 12-13 FOR MORE OPTIONS</p>	<p>WB-SHW-1180</p>	<p>\$10,800</p>

# EXPOSED SHOWER PARTS

PHOTO	DESCRIPTION	PART NUMBER	LIST PRICE
	<b>SUPPORT BRACKET FOR WATERBRIDGE SHOWER ARMS</b>	<b>CEILING MOUNT (ADJUSTABLE UP TO 17")</b>	<b>WB-SHW-ARM-BRKT-CM</b> <b>\$385</b>
		<b>45° WALL MOUNT (FIXED AT 26" LONG)</b>	<b>WB-SHW-ARM-BRKT-WM</b> <b>\$385</b>
	<b>WATERBRIDGE SHOWER ARM</b> <b>3/4" NPT, 1/2" NPS</b>	<b>12"</b> <b>WB-SHW-ARM12</b>	<b>\$490</b>
	<b>SUPPORT BRACKET IS RECOMMENDED FOR 26" ARM</b>	<b>18"</b> <b>WB-SHW-ARM18</b>	<b>\$520</b>
		<b>26"</b> <b>WB-SHW-ARM26</b>	<b>\$550</b>
	<b>45° SHOWER ARM</b> <b>5" OVERALL LENGTH</b> <b>3/4" NPT, 1/2" NPS</b>  <b>FOR USE WITH WATERBRIDGE EXPOSED SHOWERS AND PLUNGER-STYLE SHOWER HEAD</b>	<b>WB-SHW-ARM45</b>	<b>\$425</b>
	<b>HANDSHOWER SLIDEBAR</b>	<b>HS-WM-SB</b>	<b>\$800</b>
	<b>10" EXTENSION</b> <b>LOWERS TUB SPOUT FOR USE AS FOOTWASH</b>  <b>ONLY FOR WATERBRIDGE MODELS 870, 880, 970, &amp; 980</b>	<b>WB-SHW-FTWSH-1</b>	<b>\$275</b>
	<b>EXTENDED FOOTWASH SPRAY</b>  <b>REPLACES TUB SPOUT ON WATERBRIDGE MODELS 870, 880, 970, &amp; 980</b>	<b>WB-SHW-FTWSH-2</b>	<b>\$425</b>





# EXPOSED SHOWER PARTS

PHOTO	DESCRIPTION	PART NUMBER	LIST PRICE	
	<b>PLUNGER STYLE SHOWER HEAD</b> 3-1/2" FACE DIAMETER 1/2" FIP	SF-10-060	\$575	
	<b>8" SWIVELING RAINHEAD WITH RUBBER JETS</b>  1/2" FIP	SF-10-052	\$825	
	<b>12" SWIVELING RAINHEAD WITH RUBBER JETS</b>  <u>1/2" FIP</u>	SF-10-054	\$1350	
<b>SEE PAGE 28 FOR MODERN RAIN HEADS</b>				
	<b>SHOWER DOOR HANDLES</b> 9" ON CENTER - BACK TO BACK	WB-SHW-HNDL	\$820	
	<b>CLAMP WITH HAND WAND HOOK</b> ATTACHES TO TEES AND ELBOWS OF WATERBRIDGE FIXTURES	WB-ACC-CLAMP-HS	\$250	
	<b>CLAMP WITH SOAP BASKET</b> ATTACHES TO TEES AND ELBOWS OF WATERBRIDGE FIXTURES	WB-ACC-CLAMP-SD	\$525	
	<b>BACKING DISCS</b>  ATTACHES TO MOUNTING BRACKETS ON BACK SIDE OF GLASS INSTALLATIONS	SHOWER SUPPORT	WB-SHW-BKG	\$215
		HAND WAND BRACKET	WB-HS-BKG	\$215

# ACCESSORIES

PHOTO	DESCRIPTION	PART NUMBER	LIST PRICE	
	ROBE HOOK	WB-ACC-RH	\$250	
MEASURED IN OVERALL LENGTH				
	18" TOWEL BAR	WB-ACC-TB-18	\$450	
	24" TOWEL BAR	WB-ACC-TB-24	\$500	
	30" TOWEL BAR	WB-ACC-TB-30	\$550	
	PAPER TOWEL HOLDER	WB-ACC-TB-11	\$450	
	TOWEL RING	WB-ACC-TWLR	\$425	
	WIRE BASKET SOAP DISH (WALL MOUNT ONLY)	WB-ACC-SD	\$365	
	TOILET PAPER HOLDER	WB-ACC-TP-1	\$450	
	TOILET PAPER HOLDER	WB-ACC-TP-2	\$450	
	MIRROR MOUNT (SOLD INDIVIDUALLY)	WB-ACC-MIR	\$150	
	BACKING DISCS	ROBE HOOK	WB-ACC-RH-BKG	\$215
	ATTACHES TO MOUNTING BRACKETS ON BACK SIDE OF GLASS INSTALLATIONS	TOWEL BAR	WB-ACC-TB-BKG	\$215





# ACCESSORIES

PHOTO	DESCRIPTION	PART NUMBER	LIST PRICE
	2" CABINET KNOB	WB-ACC-CP	\$60
	CABINET PULLS MEASURED IN OVERALL LENGTH	5" WB-ACC-CP5	\$140
		10" WB-ACC-CP10	\$180
	DECK-MOUNTED SOAP PUMP	WB-ACC-SP-DM	\$370
	COUNTERTOP SOAP PUMP INCLUDES BASE RING FOR STABILITY	WB-ACC-SP-CT	\$550
	WALL-MOUNTED SOAP PUMP INCLUDES WALL BRACKET	WB-ACC-SP-WM	\$550
		12" GRAB BAR WB-ACC-GB12	\$405
		18" GRAB BAR WB-ACC-GB18	\$425
		24" GRAB BAR WB-ACC-GB24	\$450
		30" GRAB BAR WB-ACC-GB30	\$480
		36" GRAB BAR WB-ACC-GB36	\$515
		42" GRAB BAR WB-ACC-GB42	\$550
		48" GRAB BAR WB-ACC-GB48	\$585







MEASURED CENTER-TO-CENTER

# WHEREVER COLLECTION







PHOTO	DESCRIPTION	PART NUMBER	LIST PRICE
	<p>WIDESPREAD DECK MOUNT LAV FAUCET WITH FIXED GOOSENECK SPOUT</p> <p>6-1/2" CENTER TO AERATOR 3-1/2" SPOUT HEIGHT</p>	WE-LAV-DM-GN	\$1940
	<p>WIDESPREAD DECK MOUNT LAV FAUCET WITH WATERFALL SPOUT</p> <p>7-1/4" CENTER TO TIP 3" SPOUT HEIGHT</p>	WE-LAV-DM-WF	\$1940
	TUB FILLER	WE-RTF-DM-WF	\$2440
	<p>SHORT DECK MOUNT LAV FAUCET WITH ELBOW SPOUT</p> <p>6" CENTER TO AERATOR 3-1/2" SPOUT HEIGHT</p>	WE-LAV-DM-LBO-S	\$1940
	TUB FILLER	WE-RTF-DM-LBO-S	\$2440
	<p>TALL DECK MOUNT LAV FAUCET WITH ELBOW SPOUT</p> <p>7-1/2" CENTER TO AERATOR 9" SPOUT HEIGHT</p>	WE-LAV-DM-LBO-T	\$1940
	TUB FILLER	WE-RTF-DM-LBO-T	\$2440



# WHEREVER COLLECTION

PHOTO	DESCRIPTION	PART NUMBER	LIST PRICE
	<b>WALL MOUNT LAV FAUCET</b> 6-3/4" WALL TO AERATOR 3" DROP, CENTER TO TIP	WE-LAV-WM-7	\$1940
	TUB FILLER	WE-RTF-WM-7	\$2440
	<b>WALL MOUNT LAV FAUCET</b> 8-3/4" WALL TO AERATOR 3" DROP, CENTER TO TIP	WE-LAV-WM-9	\$1940
	TUB FILLER	WE-RTF-WM-9	\$2440
	<b>WALL MOUNT LAV FAUCET WITH WATERFALL SPOUT</b> 7-3/4" WALL TO TIP 2-3/4" DROP, CENTER TO TIP	WE-LAV-WM-WF	\$1940
	TUB FILLER	WE-RTF-WM-WF	\$2440
	<b>WALL MOUNT LAV FAUCET WITH ELBOW SPOUT</b> 5-3/4" WALL TO AERATOR 2-1/8" DROP, CENTER TO TIP	WE-LAV-WM-LBO-S	\$1940
	TUB FILLER	WE-RTF-WM-LBO-S	\$2440
	<b>WALL MOUNT LAV FAUCET WITH ELBOW SPOUT</b> 8-1/2" WALL TO AERATOR 2-1/8" DROP, CENTER TO TIP	WE-LAV-WM-LBO-L	\$1940
	TUB FILLER	WE-RTF-WM-LBO-L	\$2440









# WHEREVER COLLECTION

PHOTO	DESCRIPTION		PART NUMBER	LIST PRICE
	1/2" SINGLE CONTROL WITH PROGRESSIVE VALVE	IN-WALL	WE-WM-SC	\$1090
	TWO IN, ONE OUT  3.5 GPM - FOR USE WITH LAV SPOUT NOT PRESSURE BALANCED	DECK	WE-DM-SC	\$1090
	1/2" DIVERTER	IN-WALL 1 IN, 2 OUT	WE-WM-DIV2	
		IN-WALL 1 IN, 2 OUT W/POSITIVE SHUTOFF	WE-WM-DIV2-SO	
		IN-WALL 1 IN, 3 OUT	WE-WM-DIV3	\$850
		IN-WALL 1 IN, 3 OUT W/POSITIVE SHUTOFF	WE-WM-DIV3-SO	
		DECK 1 IN, 2 OUT	WE-DM-DIV2	
	3-1/2" REPLACEMENT "T" HANDLE		WE-HNDL-T	\$85
	3-1/2" REPLACEMENT CROSS HANDLE		WE-HNDL-C	\$85
	1-HOLE PLATE 11" X 3" OVERALL		WE-ACC-PLT-1	\$350
	3-HOLE PLATE WITH 8" SPREAD 11" X 3" OVERALL		WE-ACC-PLT-3	\$350







# WHEREVER COLLECTION

PHOTO	DESCRIPTION	PART NUMBER	LIST PRICE
	PRESSURE BALANCE CONTROL	1/2" VALVE 7" TRIM PLATE WE-PB	\$1890
		3/4" VALVE 7" TRIM PLATE WE-THERM	\$2190
	IN-WALL VOLUME CONTROL	1/2" WE-WM-1/2VC	\$850
		3/4" WE-WM-3/4VC	
	IN-WALL 1/2" DIVERTER	1 IN, 2 OUT WE-WM-DIV2	\$850
		1 IN, 2 OUT W/POSITIVE SHUTOFF WE-WM-DIV2-SO	
		1 IN, 3 OUT WE-WM-DIV3	
		1 IN, 3 OUT W/POSITIVE SHUTOFF WE-WM-DIV3-SO	
	WALL MOUNTED WATERFALL TUB SPOUT 7-3/4" WALL TO SPOUT TIP 2-3/4" DROP, CENTER TO TIP	WE-RTF-WM-WF-SPOUT	\$1275
	WALL MOUNTED 7" TUB SPOUT 6-3/4" LONG, WALL TO CENTER 3" DROP, CENTER TO TIP	WE-RTF-WM-7-SPOUT	\$1275
	WALL MOUNTED SHORT ELBOW TUB SPOUT 5-3/4" WALL TO AERATOR 2-1/8" DROP, CENTER TO TIP	WE-RTF-WM-LBO-S-SPOUT	\$1275
	WATTS REMOTE THERMOSTATIC ANTI-SCALD MIXING VALVE	SHW-WATTS	\$300

# WHEREVER COLLECTION

PHOTO	DESCRIPTION	PART NUMBER	LIST PRICE	
	LARGE 8-PLUNGER SHOWER HEAD WITH 1/2" x 8" ARM AND WALL FLANGE  3-1/2" DIAMETER FACE ADJUSTABLE SPRAY	SF-10-105	\$750	
	8" SWIVELING RAINHEAD WITH RUBBER JETS  1/2" FIP	SF-10-052	\$825	
	12" SWIVELING RAINHEAD WITH RUBBER JETS  <u>1/2" FIP</u>	SF-10-054	\$1350	
	FLANGE FOR ARMS AND NECKS	1/2" SHOWER ARMS	SF-10-102	\$55
		3/4" SHOWER ARMS	SF-10-100	\$55
	CEILING MOUNT SHOWER NECKS	1/2" x 4"	SF-10-154	\$120
		3/4" x 4"	SF-10-156	\$120
		1/2" x 8"	SF-10-140	\$140
		3/4" x 8"	SF-10-143	\$140
		1/2" x 18"	SF-10-146	\$200
		3/4" x 18"	SF-10-144	\$200
	L-SHAPED SHOWER ARMS	1/2" x 12" x 4"	SF-10-141	\$130
		1/2" x 19" x 4"	SF-10-142	\$190
		1/2" x 26" x 6"	SF-10-103	\$400
		3/4" x 26" x 6"	SF-10-106	\$430
	SUPPORT BRACKET FOR 26" ARMS	1/2"	SF-10-150	\$320
		3/4"	SF-10-151	\$320
	1/2" S-SHAPED SHOWER ARM  RAISES HEAD APPROX. 10" FROM INLET	SF-10-147	\$190	

# WHEREVER COLLECTION

PHOTO	DESCRIPTION	PART NUMBER	LIST PRICE
	<b>SUPPORT BRACKETS FOR WATERBRIDGE EXPOSED SHOWER ARMS</b>	<b>CEILING MOUNT (ADJUSTABLE UP TO 17")</b> WB-SHW-ARM-BRKT-CM	\$385
		<b>45° WALL MOUNT (FIXED AT 26" LONG)</b> WB-SHW-ARM-BRKT-WM	\$385
	<b>WATERBRIDGE SHOWER ARM</b> 3/4" NPT, 1/2" NPS  26" ARM REQUIRES SUPPORT BRACKET	12" WB-SHW-ARM12	\$490
		18" WB-SHW-ARM18	\$520
		26" WB-SHW-ARM26	\$550
	<b>45° SHOWER ARM</b> 5" OVERALL LENGTH 3/4" NPT, 1/2" NPS  ALSO USE ON WATERBRIDGE EXPOSED SHOWERS, TO ADAPT PLUNGER-STYLE SHOWER HEADS	WB-SHW-ARM45	\$425
	<b>SHOWER ARM TRIM RING</b>  FOR USE WITH ABOVE SHOWER ARMS AND CONCEALED SHOWER SYSTEMS	WE-TRIM-RING	\$55
	<b>SHOWER DOOR HANDLES</b>  9" ON CENTER - BACK TO BACK	WB-SHW-HNDL	\$820
	<b>WALL MOUNT SOAP DISH</b>	WB-ACC-SD	\$365
	<b>BODY SPRAY</b> 1/2" FIP	SF-10-063	\$295

# DECK MOUNTED HANDSHOWER KITS



PHOTO	DESCRIPTION	PART NUMBER	LIST PRICE
	DECK MOUNT HAND SHOWER KIT WITH WATERBRIDGE STYLE HAND WAND AND 59" CHROME HOSE	WB-10-276	\$950

---

SEE PAGE 28 FOR MODERN HANDSHOWER KITS

---









# WALL MOUNTED HANDSHOWER KITS

PHOTO	DESCRIPTION	PART NUMBER	LIST PRICE
	<p>WALL-MOUNTED HAND SHOWER KIT WITH WATERBRIDGE STYLE HAND WAND</p>	<p>WB-10-255</p>	<p>\$1050</p>
	<p>WALL-MOUNTED HAND SHOWER KIT WITH WATERBRIDGE STYLE HAND WAND AND 24" SLIDEBAR</p>	<p>WB-10-272</p>	<p>\$1650</p>
	<p>FINISHED 60" REPLACEMENT HOSE FOR WALL-MOUNTED HAND SHOWERS</p>	<p>SF-10-015</p>	<p>\$220</p>

SEE PAGE 28 FOR MODERN HANDSHOWER KITS

# CIXX COLLECTION

AVAILABLE WHILE SUPPLIES LAST





PHOTO	DESCRIPTION	PART NUMBER	LIST PRICE
	DECK MOUNT SHORT LAV FAUCET 4-7/8" CENTER TO AERATOR 3" SPOUT HEIGHT	CX-LAV-DM-S	\$1850
	DECK MOUNT TALL LAV FAUCET 6-3/4" CENTER TO AERATOR 2-1/2" SPOUT HEIGHT	CX-LAV-DM-T	\$1950
	TUB FILLER	CX-RTF-DM	\$2100
	WALL MOUNT LAV FAUCET 7-1/2" WALL TO AERATOR 1-3/4" CENTER TO TIP	CX-LAV-WM	\$1850
	TUB FILLER	CX-RTF-WM	\$2100
	1/2" SINGLE CONTROL WITH PROGRESSIVE VALVE TWO IN, ONE OUT 3.5 GPM - FOR USE WITH LAV SPOUT NOT PRESSURE BALANCED	WALL MOUNTED CX-WM-SC <hr/> DECK MOUNTED CX-DM-SC	\$1150
	CABINET KNOB 1-1/2" SQUARE	CX-ACC-CP	\$80
	TOILET PAPER HOLDER 10" OVERALL, SINGLE POST STYLE	CX-ACC-TP	\$430
	ROBE HOOK	CX-ACC-RH	\$385
		18" 24" 30"	CX-ACC-TB-18 CX-ACC-TB-24 CX-ACC-TB-30
	MEASURED INSIDE MOUNTING BRACKETS		\$475 \$500 \$525





# CIXX COLLECTION

PHOTO	DESCRIPTION	PART NUMBER	LIST PRICE	
	SHOWER ARM & HEAD	CX-SHW-HD	\$1850	
	3/4" THERMOSTATIC CONTROL 6" SQUARE TRIM PLATE	CX-THERM	\$2050	
	1/2" PRESSURE BALANCE CONTROL 6" SQUARE TRIM PLATE	CX-PB	\$1900	
	1/2" VOLUME CONTROL	CX-WM-1/2VC	\$900	
	3/4" VOLUME CONTROL	CX-WM-3/4VC		
	IN-WALL 1/2" DIVERTER	1 IN, 2 OUT	CX-WM-DIV2	
	IN-WALL 1/2" DIVERTER	1 IN, 3 OUT	CX-WM-DIV3	\$900
	DECK 3/4" DIVERTER	1 IN, 2 OUT	CX-DM-DIV	
	WALL TUB SPOUT	CX-RTF-WM-SPOUT	\$990	
	SHOWER DOOR HANDLES BACK-TO-BACK 10" BARS, WITH POSTS 6" C-C	CX-SHW-HNDL	\$575	



# STRAP COLLECTION

PHOTO	DESCRIPTION	PART NUMBER	LIST PRICE
	<p>WIDESPREAD DECK MOUNT LAV FAUCET WITH FIXED SPOUT</p> <p>7" CENTER TO AERATOR 3-1/2" SPOUT HEIGHT</p>	ST-LAV-DM	\$1175
	TUB FILLER WITH FIXED SPOUT	ST-RTF-DM	\$1550
	<p>WIDESPREAD WALL MOUNT LAV FAUCET WITH FIXED SPOUT</p> <p>8-3/8" WALL TO AERATOR</p>	ST-LAV-WM-L	\$1275
	TUB FILLER WITH FIXED SPOUT	ST-RTF-WM-L	\$1550
	<p>WIDESPREAD WALL MOUNT LAV FAUCET WITH FIXED SPOUT</p> <p>5-3/4" WALL TO AERATOR</p>	ST-LAV-WM-S	\$1275
	TUB FILLER WITH FIXED SPOUT	ST-RTF-WM-S	\$1550
	<p>1/2" SINGLE CONTROL WITH PROGRESSIVE VALVE</p> <p>TWO IN, ONE OUT</p> <p>3.5 GPM - FOR USE WITH LAV SPOUT NOT PRESSURE BALANCED</p>	ST-SC	\$850







## ACCESSORIES

	ROBE HOOK	ST-ACC-RH	\$230
	TOILET PAPER HOLDER	ST-ACC-TP	\$350
	18"	ST-ACC-TB18	\$420
	24"	ST-ACC-TB24	\$440
	30"	ST-ACC-TB30	\$460
MEASURED BETWEEN ESCUTCHEONS			





# STRAP CONCEALED SHOWERS

PHOTO	DESCRIPTION	PART NUMBER	LIST PRICE
	<p>PRESSURE BALANCE CONTROL</p> <p>1/2" VALVE 6-3/4" SQUARE TRIM PLATE</p>	ST-PB	\$1750
	<p>THERMOSTATIC CONTROL</p> <p>3/4" VALVE 6-3/4" SQUARE TRIM PLATE</p>	ST-THERM	\$2050
	IN-WALL VOLUME CONTROL	1/2" ST-WM-1/2VC	\$450
		3/4" ST-WM-3/4VC	
	1/2" IN-WALL DIVERTER	1 IN, 2 OUT ST-WM-DIV2	
	1/2" IN-WALL DIVERTER WITH POSITIVE SHUTOFF	1 IN, 2 OUT ST-WM-DIV2-SO	
	1/2" IN-WALL DIVERTER	1 IN, 3 OUT ST-WM-DIV3	\$450
	1/2" IN-WALL DIVERTER WITH POSITIVE SHUTOFF	1 IN, 3 OUT ST-WM-DIV3-SO	
	3/4" DECK DIVERTER	1 IN, 2 OUT ST-DM-DIV	







# STRAP CONCEALED SHOWERS

PHOTO	DESCRIPTION	PART NUMBER	LIST PRICE
	<b>8-PLUNGER SHOWER HEAD WITH 1/2" x 8" ARM AND SQUARE WALL FLANGE</b>  <b>3-1/2" DIAMETER FACE ADJUSTABLE SPRAY</b>	ST-10-105	\$775
	<b>ROUND SWIVELING RAIN HEAD WITH RUBBER JETS</b>  <b>1/2" FIP</b>	<b>7"</b> SF-10-042 <b>12"</b> SF-10-047	<b>\$800</b> <b>\$1900</b>
	<b>SQUARE SWIVELING RAIN HEAD WITH RUBBER JETS</b>  <b>1/2" FIP</b>	<b>6" x 7"</b> SF-10-037 <b>12"</b> SF-10-088	<b>\$900</b> <b>\$2300</b>
	<b>ROUND BODY SPRAY WITH SQUARE FLANGE</b>  <b>1/2" FIP</b>	ST-10-124	\$350
	<b>WALL-MOUNTED HAND SHOWER KIT WITH CONTEMPORARY HAND WAND</b>	ST-10-135	\$1150
	<b>WALL-MOUNTED HAND SHOWER KIT WITH CONTEMPORARY HAND WAND AND 24" SLIDEBAR</b>	ST-18-132	\$1950
	<b>DECK MOUNT HAND SHOWER KIT WITH CONTEMPORARY HAND WAND AND 59" CHROME HOSE</b>	ST-10-361	\$1150

# STRAP CONCEALED SHOWERS

PHOTO	DESCRIPTION	PART NUMBER	LIST PRICE
	SQUARE FLANGE FOR 1/2" ARMS AND NECKS	FOR 1/2" ARMS SF-10-049	\$110
	ROUND FLANGE FOR ARMS AND NECKS	FOR 1/2" ARMS SF-10-102	\$55
		FOR 3/4" ARMS SF-10-100	\$55
	CEILING MOUNT SHOWER NECKS	1/2" x 4" SF-10-154	\$120
		3/4" x 4" SF-10-156	\$120
		1/2" x 8" SF-10-140	\$140
		3/4" x 8" SF-10-143	\$140
		1/2" x 18" SF-10-146	\$200
		3/4" x 18" SF-10-144	\$200
	L-SHAPED SHOWER ARMS	1/2" x 12" x 4" SF-10-141	\$130
		1/2" x 19" x 4" SF-10-142	\$190
		1/2" x 26" x 6" SF-10-103	\$400
		3/4" x 26" x 6" SF-10-106	\$430
	1/2" S-SHAPED SHOWER ARM RAISES HEAD APPROX. 10" FROM INLET	SF-10-147	\$190

# SANS HANDS

PHOTO	DESCRIPTION	PART NUMBER	LIST PRICE
	<p>SANS HANDS WITH WHEREVER DECK MOUNT GOOSENECK SPOUT</p> <p>6-1/2" PROJECTION, CENTER TO AERATOR 3-1/2" SPOUT HEIGHT</p>	SANS-WE-DM-GN	\$1900
	<p>SANS HANDS WITH WHEREVER DECK MOUNT WATERFALL SPOUT</p> <p>7-1/4" PROJECTION, CENTER TO TIP 3" SPOUT HEIGHT</p>	SANS-WE-DM-WF	\$1900
	<p>SANS HANDS WITH WHEREVER DECK MOUNT ELBOW SPOUT</p> <p>SHORT: 6" PROJECTION, CENTER TO AERATOR 3-1/2" SPOUT HEIGHT</p>	SHORT SANS-WE-DM-LBO-S	\$1900
	<p>TALL: 7-1/2" PROJECTION, CENTER TO AERATOR 9" SPOUT HEIGHT</p>	TALL SANS-WE-DM-LBO-T	\$1900
	<p>SANS HANDS WITH CIXX DECK MOUNT SPOUT</p> <p>SHORT: 4-7/8" PROJECTION, CENTER TO AERATOR 3" SPOUT HEIGHT</p>	SHORT SANS-CX-DM-S	\$1900
	<p>TALL: 6-3/4" PROJECTION, CENTER TO AERATOR 2-1/2" SPOUT HEIGHT</p>	TALL SANS-CX-DM-T	\$1900
	<p>SANS HANDS WITH STRAP DECK MOUNT SPOUT</p> <p>7" PROJECTION, CENTER TO AERATOR 3-1/2" SPOUT HEIGHT</p>	SANS-ST-DM	\$1900
	<p>OPTIONAL AC ADAPTER / TRANSFORMER (CANNOT BE HARDWIRED)</p>	SANS-AC-ADAPTER	\$50

# SANS HANDS





PHOTO	DESCRIPTION	PART NUMBER	LIST PRICE
	SANS HANDS WITH WHEREVER WALL MOUNT SPOUT  6-3/4" WALL TO AERATOR 3" DROP, WALL TO TIP	SANS-WE-WM-7	\$1900
	SANS HANDS WITH WHEREVER WALL MOUNT SPOUT  8-3/4" WALL TO AERATOR 3" DROP, WALL TO TIP	SANS-WE-WM-9	\$1900
	SANS HANDS WITH WHEREVER WALL MOUNT WATERFALL SPOUT  7-3/4" WALL TO TIP 2-3/4" DROP, CENTER TO TIP	SANS-WE-WM-WF	\$1900
	SANS HANDS WITH WHEREVER WALL MOUNT SHORT ELBOW SPOUT  5-3/4" WALL TO AERATOR 2-1/8" DROP, CENTER TO AERATOR	SANS-WE-WM-LBO-S	\$1900
	SANS HANDS WITH WHEREVER WALL MOUNT LONG ELBOW SPOUT  8-1/2" LONG, WALL TO AERATOR 2-1/8" DROP, CENTER TO AERATOR	SANS-WE-WM-LBO-L	\$1900
	SANS HANDS WITH CIXX WALL MOUNT SPOUT  7-1/2" WALL TO AERATOR 1-3/4" DROP, CENTER TO AERATOR	SANS-CX-WM	\$1900
	SANS HANDS WITH STRAP WALL MOUNT SPOUT  8-1/2" WALL TO AERATOR	SANS-ST-WM	\$1900
	OPTIONAL AC ADAPTER / TRANSFORMER (CANNOT BE HARDWIRED)	SANS-AC-ADAPTER	\$50

# BRUT COLLECTION

PHOTO	DESCRIPTION	PART NUMBER	LIST PRICE
	<p>BRUT SHORT LAV FAUCET WITH FIXED ELBOW SPOUT</p> <p>6-1/2" CENTER TO AERATOR 4" SPOUT HEIGHT</p>	BRUT-LBO-S-FX	\$1800
	<p>BRUT TALL LAV FAUCET WITH FIXED ELBOW SPOUT</p> <p>7-1/2" CENTER TO AERATOR 8" SPOUT HEIGHT</p>	BRUT-LBO-T-FX	\$1800
	<p>BRUT SHORT LAV FAUCET WITH FIXED WATERFALL SPOUT</p> <p>7" CENTER TO TIP 2-1/2" SPOUT HEIGHT</p>	BRUT-WF-S-FX	\$1800
	<p>BRUT TALL LAV FAUCET WITH FIXED WATERFALL SPOUT</p> <p>7" CENTER TO TIP 7-1/2" SPOUT HEIGHT</p>	BRUT-WF-T-FX	\$1800









# BRUT COLLECTION

PHOTO	DESCRIPTION	PART NUMBER	LIST PRICE
	<p>BRUT FAUCET WITH SWIVEL SPOUT AND PULL-OUT SPRAYER</p> <p>9-3/4" CENTER-TO-AERATOR 11-1/2" SPOUT HEIGHT</p>	BRUT-PO	\$2150
	<p>BRUT FAUCET WITH SWIVEL ELBOW SPOUT</p> <p>7-1/2" CENTER-TO-AERATOR 8-1/2" SPOUT HEIGHT</p>	BRUT-PREP	\$1950
	<p>BRUT FAUCET WITH SWIVEL ELBOW SPOUT</p> <p>8-3/4" CENTER TO AERATOR 8-3/4" SPOUT HEIGHT</p>	BRUT-LBO-SW	\$1890
	<p>FAUCET WITH SIDE SPRAY</p>	BRUT-LBO-W/SP	\$2090
	BRUT SIDE SPRAY	BRUT-SP	\$385

# KITCHEN & BAR





PHOTO	DESCRIPTION	PART NUMBER	LIST PRICE	
	<b>WATERBRIDGE DECK MOUNT FAUCET WITH SQUARE SPOUT</b>  8" SPREAD, CENTER TO CENTER 9-1/2" CENTER TO AERATOR	FIXED SPOUT	WB-DM-SQ-FX	\$1975
		SWIVEL SPOUT	WB-DM-SQ-SW	\$2175
	<b>WATERBRIDGE WALL FAUCET WITH SQUARE SPOUT</b>  8" SPREAD, CENTER TO CENTER 9-1/2" SPOUT, CENTER TO AERATOR	FIXED SPOUT	WB-WM-SQ-FX	\$2025
		SWIVEL SPOUT	WB-WM-SQ-SW	\$2225
	<b>WATERBRIDGE DECK FAUCET WITH GOOSENECK SPOUT</b>  8" SPREAD, CENTER TO CENTER 6-1/2" CENTER TO AERATOR	FIXED SPOUT	WB-DM-GN-FX	\$1975
		SWIVEL SPOUT	WB-DM-GN-SW	\$2175
	<b>WATERBRIDGE WALL FAUCET WITH GOOSENECK SPOUT</b>  8" SPREAD, CENTER TO CENTER 6-1/2" CENTER TO AERATOR	FIXED SPOUT	WB-WM-GN-FX	\$2025
		SWIVEL SPOUT	WB-WM-GN-SW	\$2225
	<b>WATERBRIDGE DECK FAUCET WITH LARGE SWIVEL GOOSENECK SPOUT</b>  8" SPREAD, CENTER TO CENTER 11" CENTER TO AERATOR	SWIVEL SPOUT	WB-DM-GN-LG	\$2450
	<b>WATERBRIDGE WALL FAUCET WITH LARGE GOOSENECK SPOUT</b>  8" SPREAD, CENTER TO CENTER 11" CENTER TO AERATOR	SWIVEL SPOUT	WB-WM-GN-LG	\$2450

# KITCHEN & BAR

PHOTO	DESCRIPTION		PART NUMBER	LIST PRICE
	CUVÉE DECK MOUNT FAUCET WITH GOOSENECK SPOUT	FIXED SPOUT	CV-GN-FX	\$1250
	6-1/2" CENTER TO AERATOR 8-1/2" SPOUT HEIGHT	SWIVEL SPOUT	CV-GN-SW	\$1400
	FAUCET WITH SIDE SPRAY	SWIVEL SPOUT	CV-GN-W/SP	\$1700
	CUVÉE DECK MOUNT FAUCET WITH LARGE GOOSENECK SPOUT	SWIVEL SPOUT	CV-GN-LG	\$1500
	11" CENTER TO AERATOR 8-1/2" SPOUT HEIGHT			
	FAUCET WITH SIDE SPRAY		CV-GN-LG-W/SP	\$1800
	WINGNUT DECK MOUNT FAUCET WITH GOOSENECK SPOUT	FIXED SPOUT	WN-GN-FX	\$1250
	6-1/2" CENTER TO AERATOR 8-1/2" SPOUT HEIGHT	SWIVEL SPOUT	WN-GN-SW	\$1400
	FAUCET WITH SIDE SPRAY	SWIVEL SPOUT	WN-GN-W/SP	\$1600
	WINGNUT DECK MOUNT FAUCET WITH LARGE GOOSENECK SPOUT	SWIVEL SPOUT	WN-GN-LG	\$1500
	11" CENTER TO AERATOR 8-1/2" SPOUT HEIGHT			
	FAUCET WITH SIDE SPRAY		WN-GN-LG-W/SP	\$1800
	WINGNUT DECK MOUNT FAUCET WITH SQUARE SPOUT	FIXED SPOUT	WN-SQ-FX	\$1250
	9-1/2" CENTER TO AERATOR 6" SPOUT HEIGHT	SWIVEL SPOUT	WN-SQ-SW	\$1400
	FAUCET WITH SIDE SPRAY	SWIVEL SPOUT	WN-SQ-W/SP	\$1700
	WINGNUT SIDE SPRAY		WN-SP	\$400

# BROWNSTONE COLLECTION

AVAILABLE FOR A LIMITED TIME

PHOTO	DESCRIPTION	PART NUMBER	LIST PRICE
	<p>DECK FAUCET WITH FIXED SPOUT CERAMIC HOT &amp; COLD BUTTONS</p> <p>5-1/4" CENTER TO AERATOR 9-1/2" HEIGHT, TO SPOUT TIP</p>	BS-DM-FX	\$1400
	<p>DECK FAUCET WITH SWIVEL SPOUT CERAMIC HOT &amp; COLD BUTTONS</p> <p>6-1/2" CENTER TO AERATOR 9-5/8" HEIGHT, TO SPOUT TIP</p>	BS-DM-SW	\$1600
	<p>DECK FAUCET WITH SWIVEL SPOUT AND SIDE SPRAY CERAMIC HOT &amp; COLD BUTTONS</p> <p>6-1/2" CENTER TO AERATOR 9-5/8" HEIGHT, TO SPOUT TIP</p>	BS-DM-SW-W/SP	\$2100
	<p>DECK FAUCET WITH LARGE SWIVEL SPOUT CERAMIC HOT &amp; COLD BUTTONS</p> <p>11" CENTER TO AERATOR 9" HEIGHT, TO SPOUT TIP</p>	BS-DM-LG	\$1850
	<p>DECK FAUCET WITH LARGE SWIVEL SPOUT AND SIDE SPRAY CERAMIC HOT &amp; COLD BUTTONS</p> <p>11" CENTER TO AERATOR 9" HEIGHT, TO SPOUT TIP</p>	BS-DM-LG-W/SP	\$2250

# POINT OF USE FAUCETS

PHOTO	DESCRIPTION		PART NUMBER	LIST PRICE
	POINT OF USE FAUCET WITH ELBOW SPOUT	HOT & COLD	POU-LBO-HC	\$975
	POINT OF USE FAUCET WITH ELBOW SPOUT	COLD ONLY (HANDLE ON RIGHT)	POU-LBO-C	\$725
		HOT ONLY (HANDLE ON LEFT)	POU-LBO-H	\$750
	POINT OF USE FAUCET WITH GOOSENECK SPOUT		POU-GN-HC	\$875
	POINT OF USE FAUCET WITH GOOSENECK SPOUT	COLD ONLY (HANDLE ON RIGHT)	POU-GN-C	\$625
		HOT ONLY (HANDLE ON LEFT)	POU-GN-H	\$650











# KITCHEN & BAR

PHOTO	DESCRIPTION	PART NUMBER	LIST PRICE	
		STANDARD SINKS WITHOUT DISPOSAL	SF-11-252	\$125
	<b>KITCHEN DRAINS WITH STRAINERS</b>  <b>FITS 3-1/2" - 4" OPENINGS</b>	STANDARD SINKS WITH ISE-TYPE DISPOSAL	SF-11-361	\$135
		THICK SINKS WITHOUT DISPOSAL	SF-11-300	\$175
		THICK SINKS WITH ISE-TYPE DISPOSAL	SF-11-362	\$215
	<b>BAR SINK DRAIN WITH STRAINER</b>  <b>FITS 2" OPENINGS</b> <b>1-1/2" DRAIN, 2-7/8" FACE DIAMETER</b> <b>NO OVERFLOW</b>	DRAIN-BAR		\$140
	AIR GAP KIT	SF-37-001		\$75
	AIR SWITCH AND CONTROLLER	SF-37-018		\$360
	AIR SWITCH BUTTON ONLY	SF-37-017		\$145
	ROUND FAUCET HOLE COVER 2" DIAMETER	SF-11-270		\$40

# LAV & TUB DRAINS







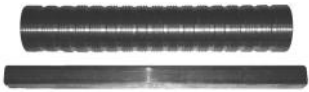

PHOTO	DESCRIPTION		PART NUMBER	LIST PRICE
	<p><b>FLIP-TOP DRAIN</b></p> <p>1-1/4" DRAIN, 2-3/8" FACE DIAMETER WITHOUT OVERFLOW</p> <p>AVAILABLE WITH OVERFLOW BY SPECIAL ORDER</p>	LAV	DRAIN-FT	\$170
	<p><b>SOFT TOUCH DRAIN</b></p> <p>WITHOUT OVERFLOW</p> <p>AVAILABLE WITH OVERFLOW BY SPECIAL ORDER</p>	LAV	DRAIN-ST	\$190
	<p><b>GRID DRAIN</b></p> <p>WITHOUT OVERFLOW</p> <p>AVAILABLE WITH OVERFLOW BY SPECIAL ORDER</p>	LAV	DRAIN-GR	\$190
	1-1/4" x 12" P-TRAP WITH FLANGE		DRAIN-TRAP	\$220
	1-1/4" x 8" DRAIN EXTENSION		DRAIN-EXT	\$140
	1-1/4" x 12" EXTENDED TAILPIECE		DRAIN-TAIL	\$95
	*FITS ONLY FLIP-TOP AND GRID DRAINS			

# FLOOR DRAINS

PHOTO	DESCRIPTION	PART NUMBER	LIST PRICE
	2" ABS FLOOR DRAIN ROUGH FOR 4" TOPS	SF-2ABS	\$130
	2" PVC FLOOR DRAIN ROUGH FOR 4" TOPS	SF-2PVC	\$130
	3" ABS FLOOR DRAIN ROUGH FOR 5" & 6" TOPS	SF-3ABS	\$130
	3" PVC FLOOR DRAIN ROUGH FOR 5" & 6" TOPS	SF-3PVC	\$130
	2" CAST IRON FLOOR DRAIN ROUGH FOR 5" & 6" TOPS	SF-2CI	\$190
	4" SQUARE DRAIN TOP	SF-4SQ	\$225
	5" SQUARE DRAIN TOP	SF-5SQ	\$325
	6" SQUARE DRAIN TOP	SF-6SQ	\$370
	4" ROUND DRAIN TOP	SF-4RND	\$445
	6" ROUND DRAIN TOP	SF-6RND	\$485



# MISCELLANEOUS / REPLACEMENT PARTS

PHOTO	DESCRIPTION	PART NUMBER	LIST PRICE
	COMPLETE SET OF STANDARD FINISH SAMPLES	FINISH SAMPLES	\$50
	20-POINT 1/2" CARTRIDGE FOR: WATERBRIDGE, WHEREVER, CIXX, AND BROWNSTONE FAUCETS	1/2-CART-20-H	\$40
		1/2-CART-20-C	\$40
	16-POINT 1/2" CARTRIDGE FOR: WINGNUT, CUVÉE, AND STRAP FAUCETS	1/2-CART-16-H	\$40
		1/2-CART-16-C	\$40
	3/4" CARTRIDGE	3/4-CART-20-H	\$50
		3/4-CART-20-C	\$50
	1" STEM EXTENSION FOR WHEREVER & CIXX CONTROLS	STEM-EXT-1	\$40
	1-1/2" STEM EXTENSION KIT FOR WHEREVER & CIXX CONTROLS  INCLUDES THREADED TUBE AND VALVE STEM EXTENSIONS, WITH .02 oz. TUBE OF ADHESIVE	STEM-EXT-1-1/2	\$85
	1-3/4" STEM EXTENSION KIT FOR STRAP CONTROLS	STEM-EXT-1-3/4	\$45
	THERMOSTATIC VALVE STEM EXTENSION REPLACEMENT 4-1/2" THREADED TUBE AND 5" INNER SQUARE TUBE	THERM-TUBE-EXT	\$130
	3/4" x 12" STRAIGHT NIPPLE	NIPPLE-3/4-12	\$65
	PACK OF FOUR 3" WOOD SCREWS WITH FINISHED HEADS	WB-SCREWS	\$35

# INDEX

PART NUMBER	PAGE	PART NUMBER	PAGE	PART NUMBER	PAGE	PART NUMBER	PAGE
1/2-CART	41	SANS-WE-WM-7	31	STEM-EXT	41	WB-SHW-1080	9
3/4-CART	41	SANS-WE-WM-9	31	ST-LAV-DM	26	WB-SHW-1140	11
BRUT-LBO-S-FX	32	SANS-WE-WM-LBO-L	31	ST-LAV-WM-L	26	WB-SHW-1150	11
BRUT-LBO-SW	33	SANS-WE-WM-LBO-S	31	ST-LAV-WM-S	26	WB-SHW-1170	11
BRUT-LBO-T-FX	32	SANS-WE-WM-WF	31	ST-PB	27	WB-SHW-1180	11
BRUT-LBO-W/SP	33	SF-10-016	23	ST-RTF-DM	26	WB-SHW-840	8
BRUT-PO	33	SF-10-037	28	ST-RTF-WM-L	26	WB-SHW-850	8
BRUT-PREP	33	SF-10-042	28	ST-RTF-WM-S	26	WB-SHW-870	8
BRUT-SP	33	SF-10-047	28	ST-SC	26	WB-SHW-880	8
BRUT-WF-S-FX	32	SF-10-049	29	ST-THERM	27	WB-SHW-940	10
BRUT-WF-T-FX	32	SF-10-052	13	ST-WM-1/2VC	27	WB-SHW-950	10
BS-DM-FX	36	SF-10-052	20	ST-WM-3/4VC	27	WB-SHW-970	10
BS-DM-LG	36	SF-10-054	13	ST-WM-DIV2	27	WB-SHW-980	10
BS-DM-LG-W/SP	36	SF-10-054	20	ST-WM-DIV3	27	WB-SHW-ARM12	12
BS-DM-SW	36	SF-10-060	13	THERM-TUBE-EXT	41	WB-SHW-ARM18	12
BS-DM-SW-W/SP	36	SF-10-063	21	WB-10-255	23	WB-SHW-ARM26	12
CV-GN-FX	35	SF-10-088	28	WB-10-272	23	WB-SHW-ARM45	12
CV-GN-LG	35	SF-10-100	20	WB-10-276	22	WB-SHW-ARM-BRKT	12
CV-GN-LG-W/SP	35	SF-10-100	29	WB-ACC-CLAMP-HS	7	WB-SHW-BKG	13
CV-GN-SW	35	SF-10-102	20	WB-ACC-CLAMP-SD	7	WB-SHW-FTWSH-1	12
CV-GN-W/SP	35	SF-10-102	29	WB-ACC-CP10	15	WB-SHW-FTWSH-2	12
CX-ACC-CP	24	SF-10-103	20	WB-ACC-CP	15	WB-SHW-HNDL	13
CX-ACC-RH	24	SF-10-103	29	WB-ACC-CP5	15	WB-WM-GN-FX	34
CX-ACC-TB	24	SF-10-105	20	WB-ACC-DM-PLT	7	WB-WM-GN-LG	34
CX-ACC-TP	24	SF-10-106	20	WB-ACC-GB	15	WB-WM-GN-SW	34
CX-DM-DIV	25	SF-10-106	29	WB-ACC-LEG EXT	7	WB-WM-SQ-FX	34
CX-DM-SC	24	SF-10-140	20	WB-ACC-MIR	14	WB-WM-SQ-SW	34
CX-LAV-DM-S	24	SF-10-140	29	WB-ACC-RH	14	WE-ACC-PLT-1	18
CX-LAV-DM-T	24	SF-10-141	20	WB-ACC-RH-BKG	14	WE-ACC-PLT-3	18
CX-LAV-WM	24	SF-10-141	29	WB-ACC-SD	14	WE-DM-DIV2	18
CX-PB	25	SF-10-142	20	WB-ACC-SD	21	WE-DM-SC	18
CX-RTF-DM	24	SF-10-142	29	WB-ACC-SP-CT	15	WE-HNDL-C	18
CX-RTF-WM	24	SF-10-143	20	WB-ACC-SP-DM	15	WE-HNDL-T	18
CX-RTF-WM-SPOUT	25	SF-10-143	29	WB-ACC-SP-WM	15	WE-LAV-DM-GN	16
CX-SHW-HD	25	SF-10-144	20	WB-ACC-TB	14	WE-LAV-DM-LBO-S	16
CX-SHW-HNDL	25	SF-10-144	29	WB-ACC-TB-BKG	14	WE-LAV-DM-LBO-T	16
CX-THERM	25	SF-10-146	20	WB-ACC-TEE	7	WE-LAV-DM-WF	16
CX-WM-1/2VC	25	SF-10-146	29	WB-ACC-TP-1	14	WE-LAV-WM-7	17
CX-WM-3/4VC	25	SF-10-147	20	WB-ACC-TP-2	14	WE-LAV-WM-9	17
CX-WM-DIV	25	SF-10-147	29	WB-ACC-TWLR	14	WE-LAV-WM-LBO-L	17
CX-WM-SC	24	SF-10-150	20	WB-ACC-WM-PLT	7	WE-LAV-WM-LBO-S	17
DRAIN-BAR	38	SF-10-151	20	WB-DM-GN-FX	34	WE-LAV-WM-WF	17
DRAIN-EXT	39	SF-10-154	20	WB-DM-GN-LG	34	WE-PB	19
DRAIN-FT	39	SF-10-154	29	WB-DM-GN-SW	34	WE-RTF-DM-LBO-S	16
DRAIN-GR	39	SF-10-156	29	WB-DM-SQ-FX	34	WE-RTF-DM-LBO-T	16
DRAIN-ST	39	SF-11-252	38	WB-DM-SQ-SW	34	WE-RTF-DM-WF	16
DRAIN-TAIL	39	SF-11-257	39	WB-HNDL-T	7	WE-RTF-WM-7	17
DRAIN-TRAP	39	SF-11-269	39	WB-HS-BKG	13	WE-RTF-WM-7-SPOUT	19
FINISH SAMPLES	41	SF-11-270	38	WB-LAV-DM-LBO-S	5	WE-RTF-WM-9	17
HS-WM-SB	12	SF-11-300	38	WB-LAV-DM-LBO-T	5	WE-RTF-WM-LBO-L	17
NIPPLE-3/4-12	41	SF-11-361	38	WB-LAV-DM-WF-S	4	WE-RTF-WM-LBO-S	17
POU-GN-C	37	SF-11-362	38	WB-LAV-DM-WF-T	4	WE-RTF-WM-LBO-S-SPOUT	19
POU-GN-H	37	SF-2ABS	40	WB-LAV-WM-LBO	5	WE-RTF-WM-WF	17
POU-GN-HC	37	SF-2PVC	40	WB-LAV-WM-WF	4	WE-RTF-WM-WF-SPOUT	19
POU-LBO-C	37	SF-37-001	38	WB-RTDO	4	WE-THERM	19
POU-LBO-H	37	SF-37-017	38	WB-RTF-DM-LBO	5	WE-TRIM-RING	21
POU-LBO-HC	37	SF-37-018	38	WB-RTF-DM-LBO	5	WE-WM-1/2VC	19
SANS-AC-ADAPTER	31	SF-3ABS	40	WB-RTF-FM-LBO	5	WE-WM-3/4VC	19
SANS-CX-DM-S	30	SF-3PVC	40	WB-RTF-FM-LBO-CSTM	5	WE-WM-DIV	19
SANS-CX-DM-T	30	SF-4RND	40	WB-RTF-FM-LBO-HS	6	WE-WM-SC	18
SANS-CX-WM	31	SF-4SQ	40	WB-RTF-FM-WF	4	WN-GN-FX	35
SANS-ST-DM	30	SF-5SQ	40	WB-RTF-FM-WF-CSTM	4	WN-GN-LG	35
SANS-ST-WM	31	SF-6RND	40	WB-RTF-FM-WF-HS	6	WN-GN-LG-W/SP	35
SANS-WE-DM-GN	30	SF-6SQ	40	WB-RTF-WM-LBO	5	WN-GN-SW	35
SANS-WE-DM-LBO-S	30	SF-CI	40	WB-RTF-WM-LBO-HS	6	WN-GN-W/SP	35
SANS-WE-DM-LBO-T	30	SHW-WATTS	19	WB-RTF-WM-WF	4	WN-SP	35
SANS-WE-DM-WF	30	ST-10-105	28	WB-RTF-WM-WF-HS	6	WN-SQ-FX	35
		ST-10-124	28	WB-SCREWS	41	WN-SQ-SW	35
		ST-10-132	28	WB-SHW-1040	9	WN-SQ-W/SP	35
		ST-10-135	28	WB-SHW-1050	9		
		ST-10-361	28	WB-SHW-1070	9		
		ST-ACC-RH	26				
		ST-ACC-TB	26				
		ST-ACC-TP	26				
		ST-DM-DIV	27				

# SONOMA FORGE TERMS & CONDITIONS

## **PRICING**

Lav, Tub, and Shower products include rough valves and trim. Unless otherwise noted, all products are priced individually. Most lav faucet kits include one matching drain.

Shipping, handling, duties, taxes, storage, payment processing fees, etc., are not included.

## **SHIPPING**

Shipping charges are always prepaid by Sonoma Forge. "Freight Collect" and "Third Party" are not available.

Products ship via ground carrier unless requested otherwise. Tracking information is listed on the invoice.

Invoices equal to or greater than \$10,000 qualify for free domestic ground shipping.

Additional charges may apply for lift gate service, excess insurance, residential delivery, inside delivery, limited access delivery, call before delivery, guaranteed delivery, weekend delivery, holiday delivery, changes in delivery, and expedited delivery. Cancelling or returning items that reduce the invoiced total to below \$10,000 will result in billing of the entire shipping charges.

## **WARRANTY**

Sonoma Forge products are assembled and finished by hand in the USA. Each part is unique and individual, and may vary slightly from one part to another. Living finishes will change over time, to degrees dependent on environment. This is natural, and these changes are not warranted.

We warrant the quality of our products to be free of manufactured defects and will repair any defective product up to two years from purchase date. Product will be replaced if not repairable, at the discretion of Sonoma Forge.

Replacement parts may not be available for discontinued products after two years of purchase.

Products installed outdoors do not qualify for complete warranty.

Damage from freezing temperatures is not covered under warranty.

Sonoma Forge shall not be responsible or held liable for labor, installation, removal, or shipping charges; consequential, incidental, indirect, special, economic, or punitive damages; as well as illness injury, disability, or death from installation or use of our products.

## **CLAIMS**

All orders must be inspected upon receipt. Damage or discrepancies must be reported to Sonoma Forge within three (3) business days of delivery, and before product leaves the original delivery address.

Packaging with visible damage should be noted with the carrier upon receipt. Packages should be refused if product damage is obvious from the outside of the packaging.

Sonoma Forge is not liable for lost or damaged product drop-shipped to a dealer's customer. The dealer takes full responsibility for any drop-shipped product after it has shipped from Sonoma Forge.

## **RETURNS & CANCELLATIONS**

No returns will be accepted without prior authorization from Sonoma Forge.

Sonoma Forge is not responsible for any labor, packaging, shipping costs or damage of returning product.

Restocking fees will be assessed based on several conditions, not limited to:

- Date of original invoice:
  - Up to 30 days: 25%
  - 31 to 60 days: 35%
  - 61 to 90 days: 50%
  - 91+ days: negotiable
- Used, damaged, and custom products are not returnable.

Order cancellations are only accepted by email, and are subject to a fee of up to 75%.

## **CARE & MAINTENANCE**

Wipe with a clean, soft, damp cloth. Mild soap may be used. Blot dry.

100% carnauba wax can be used properly to protect finishes.

For information or parts not listed in our price book, please contact Sonoma Forge.



**SONOMA FORGE**  
DESIGNER FAUCETS

Introducing Matte Black  
As A New Standard Finish

